

IN APPLICATION

Underwater 3D Flow Field Measurement

Lagrangian Particle Tracking with MiniShaker Underwater

Introduction

Underwater measurements in towing tanks, cavitation tunnels, or offshore facilities imply extraordinary challenges for the experimentalist and his equipment. The measurement system should be remotely controlled and flexible, easy to use and reliable even in the harsh environment of a towing tank at high speeds. Furthermore, the system must provide robust calibration routines for accurate results or, preferably, be alignment-free. A customizable hardware design with minimal physical influence on the measured flow field, software with state-of-the-art data analysis algorithms and a convenient user interface are essential.

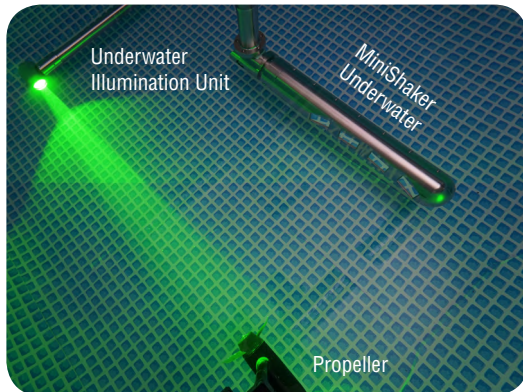

Figure 1: Underwater measurement of a propeller wake. Left: Top view without propeller rotation with smooth water surface, right: side view with experiment in progress.

The solution is LaVision's Underwater PIV systems^[1] for planar 2D- and Stereo-PIV and volumetric flow field measurements with Tomographic PIV (Tomo-PIV)^[2] or Shake-the-Box (STB)^[3]. Combined with a LaVision DIC (Digital Image Correlation) system, then fluid-structure interaction (FSI) phenomena can be analyzed.

Based on the previous experience in fully customizable and flexible underwater Tomo-PIV and STB systems with remote control of cameras, lenses and illumination, LaVision has now developed an alignment-free system: **MiniShaker Underwater** with its **Underwater Illumination Unit**. It is the solution for underwater measurements of flow fields in a volume of approximately 30x20x15 cm³ (WxHxD). Cameras and lenses are set to a fixed focal distance, aperture and position, optimized for the ideal camera overlap.

System Components

MiniShaker Underwater is an in-line 4-camera system. The camera arrangement in a stainless-steel tube ensures minimal drag. The rotation and position of the probe can be adapted to the measurement task, as illustrated in figure 2.

Once submerged and calibrated, e.g. with a single view of LaVision's 3D calibration target, the rigid mounting of the **MiniShaker Underwater** combined with LaVision's patented Volume Self-Calibration ensures a high measurement quality over hours and days including multiple runs in a towing tank.

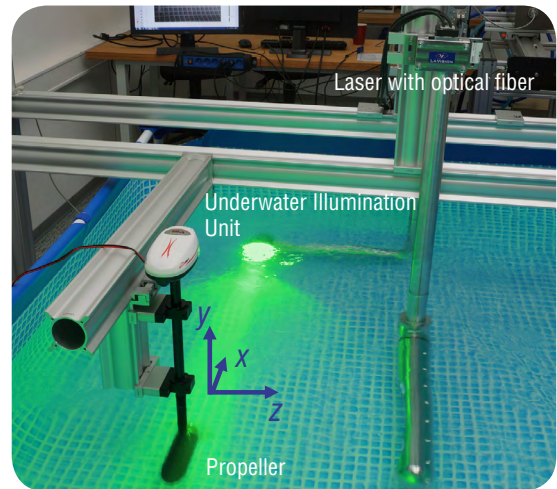

Tomo-PIV and STB require volumetric illumination of the tracer particles. High-speed lasers can now be delivered through an optical fiber, protected by a fully customizable stainless steel tube housing, in the LaVision **Underwater Illumination Unit**, as shown in figure 1. The optics of the illumination unit shapes the laser light into a pyramid with sharp edges tailored to the **MiniShaker Underwater** probe. For increased flexibility the laser exit can be rotated around one axis as sketched in figure 3.

The whole system is controlled by LaVision's Data Acquisition and Visualization software (DaVis 10) with the programmable timing unit PTU X for easy and flexible control of all system components. For 3D flow measurements, the user has the choice between double-frame and time-resolved measurements both accessible in the Tomo-PIV and STB software.

LaVisionUK Ltd

2 Minton Place / Victoria Road
Bicester, Oxon / OX26 6QB / United Kingdom
E-mail: sales@lavision.com / www.lavisionuk.com
Phone: +44-(0)-870-997-6532 / Fax: +44-(0)-870-762-6252

LaVision GmbH

Anna-Vandenhoeck-Ring 19
D-37081 Göttingen / Germany
E-mail: info@lavision.com / www.lavision.com
Tel. +49-(0)551-9004-0 / Fax +49-(0)551-9004-100

LaVision Inc.

211 W. Michigan Ave. / Suite 100
Ypsilanti, MI 48197 / USA
E-mail: sales@lavisioninc.com / www.lavisioninc.com
Phone: (734) 485 - 0913 / Fax: (240) 465 - 4306

Underwater 3D Flow Field Measurement

Lagrangian Particle Tracking with MiniShaker Underwater

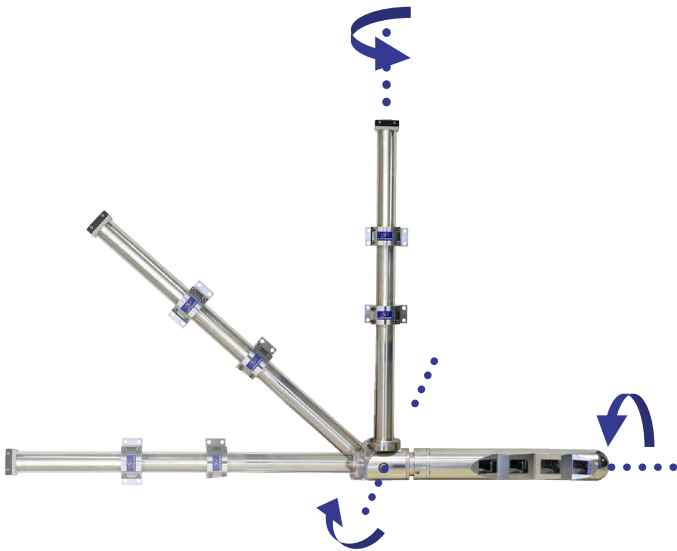

Figure 2: MiniShaker Underwater with its rotation axes.



Figure 3: Laser exit of the Underwater Illumination Unit with rotation axis for positioning of the light cone. The shape of the laser light volume is illustrated in green.

The Pressure from PIV^[4,5] module allows for full-field pressure reconstruction. Furthermore, the Fine Scale Reconstruction^[6,7] software feature guarantees the highest measurement resolution from particle tracks to be obtained on a regular grid, while ensuring that the measured flow adheres to the flow governing equations. Examples can be seen in figures 13 and 14.

Measurement behind a propeller

In the design of a boat's propeller, the key parameters are maximized thrust with minimized fuel consumption. Additionally, avoiding cavitation, reducing noise generation and understanding the resulting pressure fields are of vital importance. These complex demands often necessitate experimental tests complementing CFD simulations. Here, we demonstrate the new **MiniShaker Underwater** measurement system at this common problem of engineering interest with an experiment using the principle of similtude to take scale model measurements in a small water pool.

A boat's propeller (2 blades, rotor diameter 15 cm) is submerged in the pool, as illustrated in figure 1. LaVision's Polyamide particles HQ, 60 μm , 1.03 g/cm^3 serve as tracers. A Nd:YLF DM 30 single head laser is coupled into the fiber of the **Underwater Illumination Unit**, which is positioned in the far wake of the propeller. In this way, the laser light illuminates the propeller wake, as shown in figure 1. The **MiniShaker Underwater** probe is mounted in such a way that the four cameras are arranged parallel to the main flow direction of the propeller wake. Figure 5 shows a raw camera image. The propeller is just visible at the very left of each camera image.

For the initial calibration, a single view of a 3D calibration target (LaVision Type 31) positioned in the region of the flow field of interest is recorded. The required calibration quality (below 0.1 px)^[2] is subsequently achieved by using Volume Self-Calibration^[8,9].

Volume Self-Calibration

For high-resolution 3D measurements, a good calibration quality (recommendable <0.1 px error)^[2] is essential. It is often impossible to maintain this accuracy based on an initial calibration over multiple measurements as even temperature changes can affect the quality. In Volume Self-Calibration^[8,9], the

particles themselves are the reference for a refined calibration. Computationally efficient particle position triangulation yields a direct correction of the calibration optimizing the mapping function between camera images and particle positions in 3D space.

LaVisionUK Ltd

2 Minton Place / Victoria Road
Bicester, Oxon / OX26 6QB / United Kingdom
E-mail: sales@lavisoin.com / www.lavisoinuk.com
Phone: +44-(0)-870-997-6532 / Fax: +44-(0)-870-762-6252

LaVision GmbH

Anna-Vandenhoeck-Ring 19
D-37081 Göttingen / Germany
E-mail: info@lavisoin.com / www.lavisoin.com
Tel. +49-(0)551-9004-0 / Fax +49-(0)551-9004-100

LaVision Inc.

211 W. Michigan Ave. / Suite 100
Ypsilanti, MI 48197 / USA
E-mail: sales@lavisoinc.com / www.lavisoinc.com
Phone: (734) 485 - 0913 / Fax: (240) 465 - 4306

Underwater 3D Flow Field Measurement

Lagrangian Particle Tracking with MiniShaker Underwater

The propeller wake is recorded at a frame rate of 511 Hz with a sensor resolution of 896 x 656 px in each camera and a camera exposure time of 105 μ s. The recording is collected in time-resolved mode with the cameras and laser triggered at the same rate, such that the time interval (dt) between the images is intrinsically tied to the recording rate.

Image preprocessing

An ideal particle image for Shake-the-Box processing shows clear, Gaussian-shaped particle peaks without peak-locking^[10] with a constant particle intensity and background levels with nominally zero values.

The raw images clearly show a strong image background due to the surface texture of the pool reflecting the laser light pulses. Also the rotating propeller generates strong reflections. Both are visible in the raw image displayed in figure 5.

Removing the temporally constant background structure is straightforward in DaVis with its built-in capabilities for subtracting the sliding temporal minimum count of each pixel over multiple time steps. Here, ± 4 time steps are used. Further spatial filtering optimizes the signal uniformity and signal-to-noise ratio. Changing with time, the main reflections at the edges of the rotor blades and at the front of the rotor are still visible after this preprocessing. These are removed from the images by algorithmic masking yielding an individual mask for each image. Figure 6 shows the result of all preprocessing steps for the raw image in figure 5.

Adaptive Masking

Due to moving parts, in many applications the background of particle recordings is not temporally constant. Resulting reflections recorded by the cameras often have to be separated from the particle signal of interest. DaVis provides dedicated image processing algorithms to automatically generate a customizable and individual mask for each camera image.

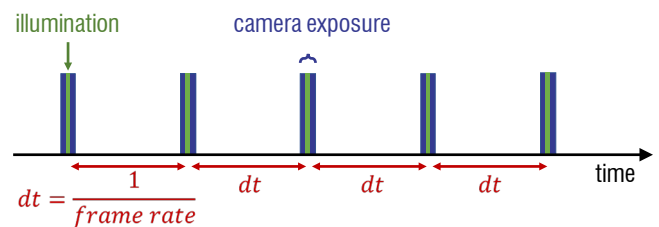

Figure 4: Time-resolved recording: The camera images are recorded at a constant frame rate with a single illumination per frame which intrinsically connects the time interval dt to the recording rate, yielding time-resolved data.

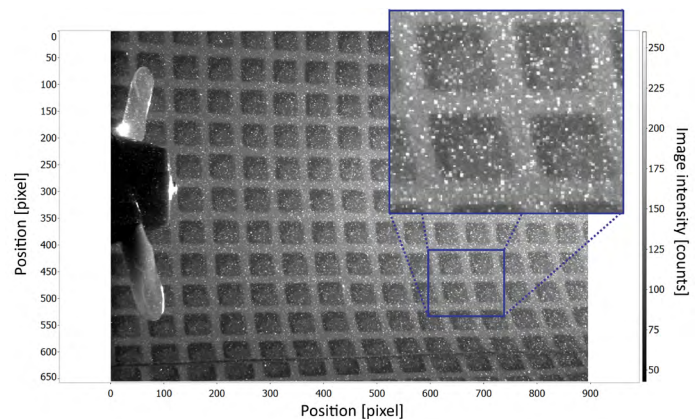

Figure 5: Raw camera image with zoomed area clearly showing the seeding above the background influenced by the texture of the pool foil.

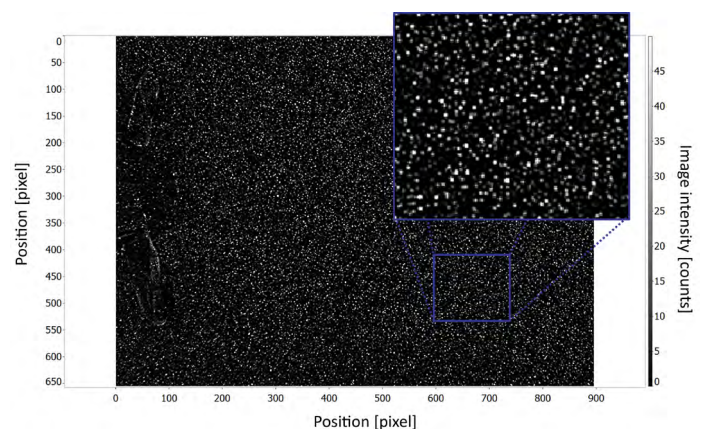

Figure 6: Camera image after preprocessing including algorithmic masking. With algorithmic masking the reflections by the propeller are barely visible. The zoomed area clearly shows the prominent particle signal over the suppressed background.

Underwater 3D Flow Field Measurement

Lagrangian Particle Tracking with MiniShaker Underwater

High Density Particle Tracking: Shake-the-Box

The coordinate system is defined as sketched in figure 7. The x-axis points in the main flow direction towards the **Underwater Illumination Unit**, the y-axis points vertically upwards, whereas $z = 0$ is in a distance of 60 cm to the **MiniShaker Underwater**.

The u -velocity component of roughly 2.5 m/s corresponds to a maximum shift of approximately 16 px between two consecutive images. In the temporal average, the flow is axisymmetric. Hence, the average shifts in y - and z -directions are expected to be equal. They are below 9 px corresponding to approximately 1.35 m/s.

The basis of the flow analysis is time-resolved Shake-the-Box^[3]. Taking into account the spatial and temporal information in the recordings, this fast algorithm is ideal for highest particle densities. STB-tracks retrieved in 15 consecutive images color coded by velocity magnitude are shown in figure 7.

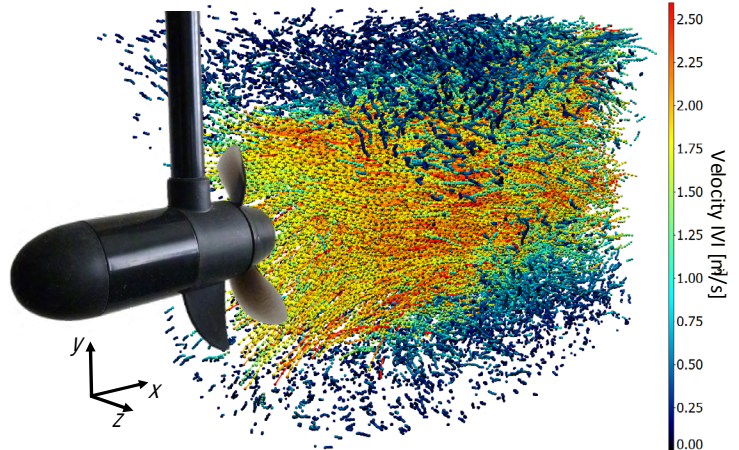

Figure 7: STB particle tracks in the propeller wake in 15 consecutive time steps color coded by velocity magnitude.

Shake-the-Box

Shake-the-Box^[3] finds particles via 3D triangulation and ‘shaking’^[11] each particle in space to find the best possible match with the recorded camera images. Then, for each detected particle, the particle images on all camera sensors are found and subtracted from the camera images. This yields residual camera images only showing the signal from the remaining particles, revealing previously obscured particle images. Iteratively, new particles are ‘shaken’ into place.

This process has been further optimized by using knowledge about the optical imaging conditions in the recording. Due to image aberrations, e.g. caused by the camera lenses, the same particle in different positions in the volume can generate differently shaped particle images on a camera sensor. This knowledge is stored in the optical transfer function^[12] (OTF) optimized for the current recording. The OTF serves as a look-up-table in STB processing. This ensures that even minor image aberrations are taken into account, which optimizes 3D particle position detection. The OTF also provides the appropriate particle images for computing residual camera images maximizing resolvable particle densities.

After an initialization phase, the temporal information is taken into account. In time-resolved STB^[3], a second order polynomial function is fit to each detected particle track. This yields a prediction of the particle position in the subsequent time step. In the next time step, the algorithm prioritizes the search for particles in the vicinity of each predicted 3D particle position by ‘shaking’ the 3D particles into positions that maximize the match with the camera images. Then, the particle images are subtracted from the camera images. The resulting residual images contain only the particles that have yet to be tracked making the algorithm computationally efficient.

The combination of spatial and temporal information leads to highest-quality volumetric flow fields. Notably, STB has received an award in the latest PIV Challenge^[13].

Multi-pulse STB, using double-frame recordings, takes advantage of the temporal information in the two camera frames^[14]. Here, either two particle positions (one per frame, 2-pulse STB) or four positions (two per frame, 4-pulse STB) are tracked.

LaVisionUK Ltd

2 Minton Place / Victoria Road
Bicester, Oxon / OX26 6QB / United Kingdom
E-mail: sales@lavision.com / www.lavisionuk.com
Phone: +44-(0)-870-997-6532 / Fax: +44-(0)-870-762-6252

LaVision GmbH

Anna-Vandenhoeck-Ring 19
D-37081 Göttingen / Germany
E-mail: info@lavision.com / www.lavision.com
Tel. +49-(0)551-9004-0 / Fax +49-(0)551-9004-100

LaVision Inc.

211 W. Michigan Ave. / Suite 100
Ypsilanti, MI 48197 / USA
E-mail: sales@lavisioninc.com / www.lavisioninc.com
Phone: (734) 485 - 0913 / Fax: (240) 465 - 4306

Underwater 3D Flow Field Measurement

Lagrangian Particle Tracking with MiniShaker Underwater

Results

400 time steps have been processed. In average more than 8300 particles are tracked including round 850 new tracks entering the volume in each time step. All particles are tracked in a volume shaped approximately like a truncated rectangular pyramid due to the camera overlap in the in-line arrangement. The resulting volume is visible in the projections shown in figure 8.

Data binning with Gaussian weighting is used for retrieving a flow field on a regular grid. Data binning requires at least one particle track per bin, which limits the spatial resolution for instantaneous data. A temporal average accumulates the information from many time steps increasing the achievable spatial resolution^[15]. Figure 9 shows the y-component of the acceleration averaged over 300 time steps at $z = 4$ cm. Being the second derivative of the particle track, the acceleration data is usually noisier than the velocity field. Still, the acceleration distribution from an average of only 300 time steps is significantly consistent with the expected flow pattern.

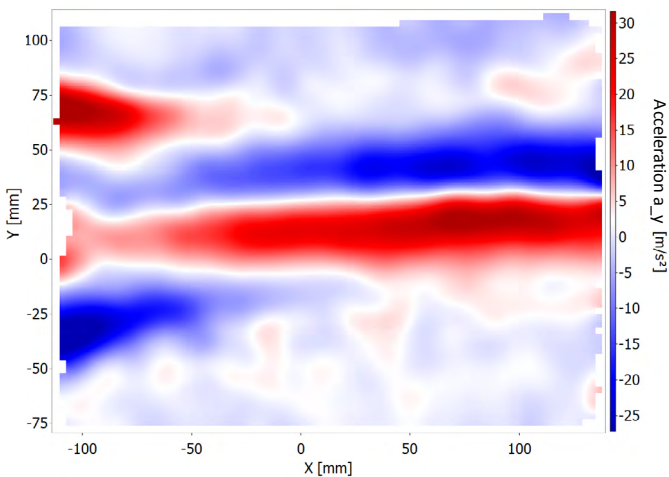

Figure 9: Temporal average over 300 time steps of the y component of acceleration at $z = 4$ cm retrieved by data binning.

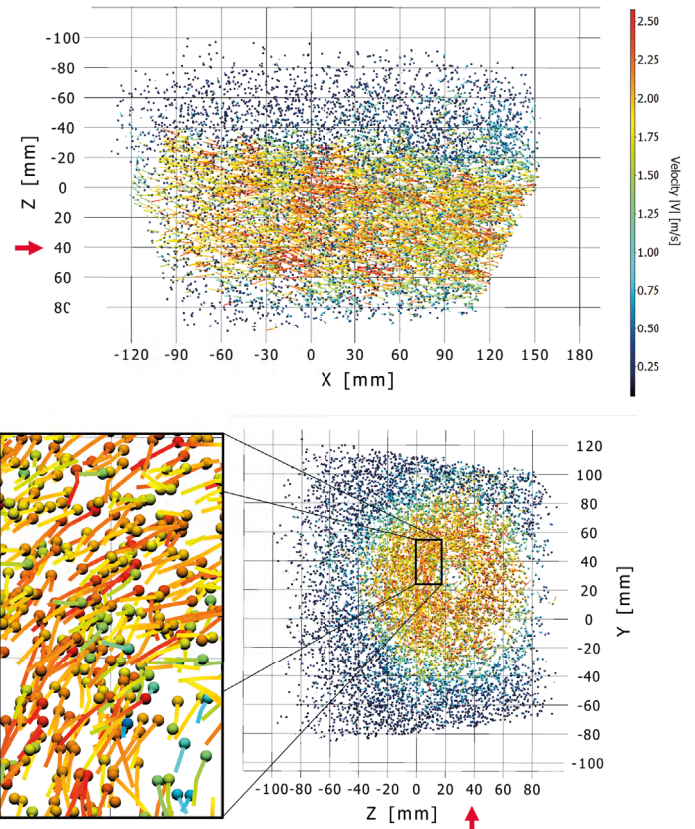

Figure 8: Two projections of STB tracks over 3 consecutive time steps, color-coded by velocity magnitude, top: main flow direction from left to right, bottom: main flow direction into the plane. Spheres are displayed at the end position of each track. Red arrows mark the plane shown in figure 9.

LaVisionUK Ltd

2 Minton Place / Victoria Road
Bicester, Oxon / OX26 6QB / United Kingdom
E-mail: sales@lvision.com / www.lvisionuk.com
Phone: +44-(0)-870-997-6532 / Fax: +44-(0)-870-762-6252

LaVision GmbH

Anna-Vandenhoeck-Ring 19
D-37081 Göttingen / Germany
E-mail: info@lvision.com / www.lvision.com
Tel. +49-(0)551-9004-0 / Fax +49-(0)551-9004-100

LaVision Inc.

211 W. Michigan Ave. / Suite 100
Ypsilanti, MI 48197 / USA
E-mail: sales@lvisioninc.com / www.lvisioninc.com
Phone: (734) 485 - 0913 / Fax: (240) 465 - 4306

Underwater 3D Flow Field Measurement

Lagrangian Particle Tracking with MiniShaker Underwater

For an impression of the instantaneous flow topology, particle tracks are usually converted to a regular grid. Here, two methods are used: Binning with Gaussian weighting and Fine Scale Reconstruction using information from the governing fluid dynamics equations (Navier-Stokes). In both methods the tracks are fit with polynomials of second order with a length of 5 time steps to retrieve velocity and acceleration. The final resolution of the grid is set to 12 vox in each dimension.

Figure 10 shows the results of binning and of Fine Scale Reconstruction for the same time step (without temporal averaging). The isosurfaces represent a swirl strength $\lambda_2 = -1300 \text{ s}^{-2}$. The color scale is the vorticity component ω_x .

In particle binning, a grid point is regarded as valid if a single particle track was present in the respective bin. Still, the flow field has data gaps, which are not present in Fine Scale Reconstruction. Binning is suitable for a quick preview of instantaneous results, whereas Fine Scale Reconstruction is the method of choice for recovering the details of the flow field. The resolution can be even further increased as shown below in figure 13, whereas simple binning exposes too many data gaps on a finer scale.

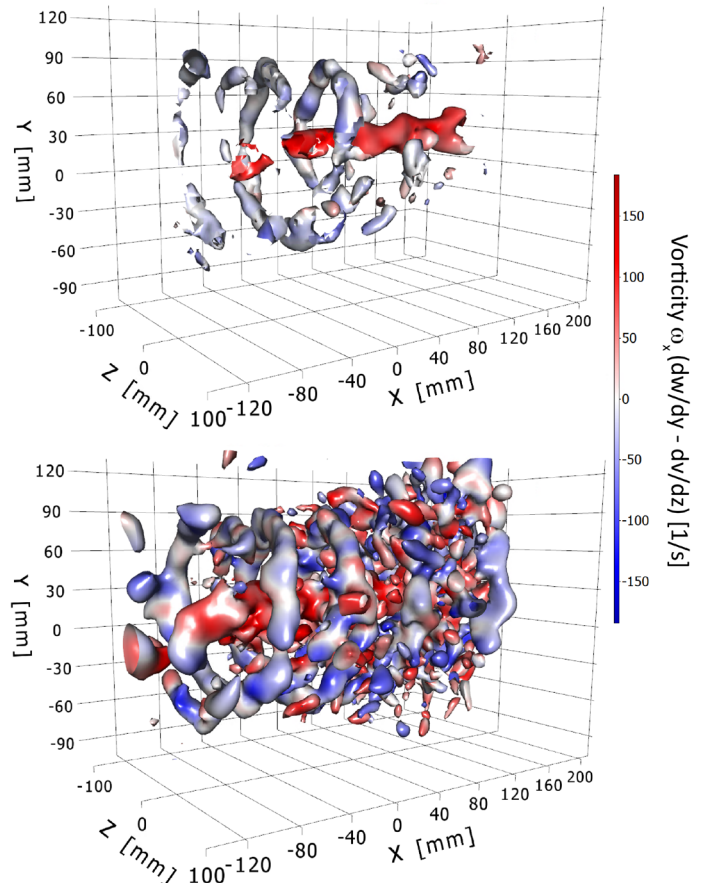

Figure 10: Isosurfaces at $\lambda_2 = -1300 \text{ s}^{-2}$ color coded by vorticity component ω_x retrieved with data binning (top) and fine scale reconstruction (bottom) both for a final grid resolution of $12 \times 12 \times 12$ vox showing a single time step of a time-resolved analysis.

Convert Lagrangian particle tracks to a Eulerian grid: Data Binning and Fine Scale Reconstruction

With a polynomial fit, velocity and acceleration are readily obtained from a particle track. Usually, this is only a first step in the flow analysis followed by calculating further quantities on a regular grid, like vorticity, swirl strength or pressure. To convert track data to a regular grid, the experimentalist can select from two methods: Either the traditional data binning which interpolates the data between the particle tracks or modern data assimilation algorithms which fill the gaps between tracks with the help of physical laws^[6].

In DaVis, binning uses Gaussian weighting reflecting the distance of a particle track to the grid point with optional use of spatial polynomial regression^[16]. The final grid resolution obtained works with window overlap similar as in Tomo-PIV, e.g. 75% overlap yields a resolution of 12 vox for an initial resolution of 48 vox.

The data assimilation method Fine Scale Reconstruction^[7] uses Navier-Stokes equation and vorticity transport equation. Hence, the resolution is enhanced by finding a solution respecting the governing equations instead of simple interpolation. This resolves fine scales unreachable by simple data binning.

LaVisionUK Ltd

2 Minton Place / Victoria Road
Bicester, Oxon / OX26 6QB / United Kingdom
E-mail: sales@lavisoin.com / www.lavisoinuk.com
Phone: +44-(0)-870-997-6532 / Fax: +44-(0)-870-762-6252

LaVision GmbH

Anna-Vandenhoeck-Ring 19
D-37081 Göttingen / Germany
E-mail: info@lavisoin.com / www.lavisoin.com
Tel. +49-(0)551-9004-0 / Fax +49-(0)551-9004-100

LaVision Inc.

211 W. Michigan Ave. / Suite 100
Ypsilanti, MI 48197 / USA
E-mail: sales@lavisoinc.com / www.lavisoinc.com
Phone: (734) 485 - 0913 / Fax: (240) 465 - 4306

Underwater 3D Flow Field Measurement

Lagrangian Particle Tracking with MiniShaker Underwater

The time-averaged result over 300 time steps (0.6 s) is complemented by Pressure from PIV^[4,5] in DaVis. Here, the data on a regular grid of spatial resolution 10x10x10 vox retrieved with Gaussian binning is used to evaluate the time-averaged relative pressure under the condition of average pressure at 0 Pa. Six planes of the volume are shown in figure 11 together with the time-averaged velocity field displayed as vectors. Clearly, the low-pressure core in the vortex can be identified.

Figure 11: Six planes of the time-averaged pressure field over 0.6 s based on Gaussian binning of STB tracks. Every 4th vector of the average velocity field is displayed.

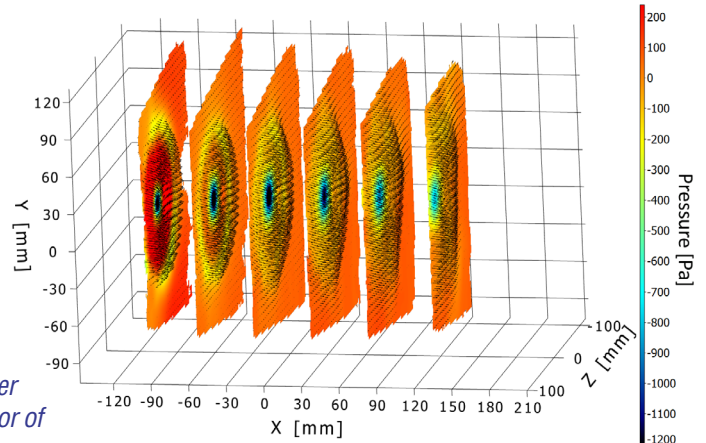

Pressure from PIV

Traditionally pressure measurements are obtained pointwise, e.g. with pressure taps as shown in figure 12. This requires a tedious and expensive process from the experimentalist, who, for instance, has to equip a ship model with multiple pressure sensors. The demand for non-intrusive full-volume pressure measurements led to the European research project NIOPLEX^[4], in which several universities and LaVision joined forces to find practical ways for pressure retrieval from PIV measurements.

Further inhouse developments including a 4D solver^[5] and Fine Scale Reconstruction enhanced the capabilities of Pressure from PIV. Now Pressure from PIV can obtain instantaneous and time-averaged pressure fields in 2D-PIV, Stereo-PIV, Tomographic PIV and Shake-the-Box combined with data binning or Fine Scale Reconstruction. Although Pressure from PIV relies on the measurement of the material acceleration term, the use of Fine Scale Reconstruction allows for instantaneous pressure to be calculated from 2-pulse STB data.

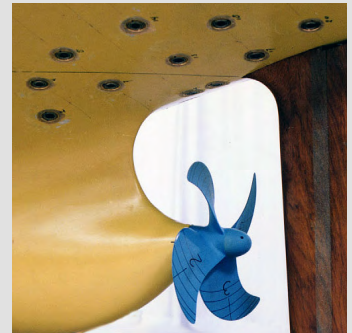

Figure 12: Pressure tabs on a ship's hull, courtesy Mr. Frans Hendrik Lafeber, MARIN

References:

- [1] Application Note "Underwater PIV in High Velocity Towing Tanks" at <https://www.lavision.de/en/products/flowmaster/underwater-piv/index.php>
- [2] Elsinga et al. "Tomographic Particle Image Velocimetry" *Exp. Fluids* 41(6):933- 947 (2006)
- [3] Schanz et al. "Shake-the-box: Lagrangian particle tracking at high particle image densities" *Exp. Fluids* 57:70 (2016)
- [4] NIOPLEX "Non-intrusive Optical Pressure and Loads Extraction for Aerodynamic Analysis" <http://nioplex.eu>
- [5] Jeon et al. "Boundary condition assignment for evaluating instantaneous pressure field from Time-resolved PIV" ISPIV Conference Session M on Monday 19th at 11:15 (2017)
- [6] Schneiders and Scarano "Dense velocity reconstruction from tomographic PTV with material derivatives" *Exp. Fluids* 57(9):139 (2016)
- [7] Jeon et al. "4D flow field reconstruction from particle tracks by VIC+ with additional constraints and multigrid approximation" ISFV Conference (2018)
- [8] Wieneke "Volume self-calibration for 3D particle image velocimetry" *Exp. Fluids* 45:549-556 (2008)
- [9] Wieneke "Improvements for volume self-calibration" *Meas. Sci. Technol.* 29 (2018) 084002
- [10] Michaelis et al. "Peak-locking reduction for particle image velocity" *Meas. Sci. Technol.* 27 (2016) 104005
- [11] Wieneke "Iterative reconstruction of volumetric particle distribution" *Meas. Sci. Technol.* 24 (2013) 024008
- [12] Schanz et al. "Non-uniform optical transfer functions in particle imaging: calibration and application to tomographic reconstruction" *Meas.Sci. Technol.* 24 (2013) 024009
- [13] Kähler et al. "Main results of the 4th International PIV Challenge" *Exp. Fluids* (2016) 57:97
- [14] Novara et al. "Multi-exposed recordings for 3D Lagrangian particle tracking with Multi-Pulse Shake-The-Box" *Exp. Fluids* (2019) 60:40
- [15] Kähler et al. "On the resolution limit of digital particle image velocimetry" *Exp. Fluids* (2012) 52:1629-1639
- [16] Agüera et al. "Ensemble 3D PTV for high resolution turbulent statistics" *Meas. Sci. Technol.* 27(12):124011 (2016)

LaVisionUK Ltd

2 Minton Place / Victoria Road
Bicester, Oxon / OX26 6QB / United Kingdom
E-mail: sales@lavision.com / www.lavisionuk.com
Phone: +44-(0)-870-997-6532 / Fax: +44-(0)-870-762-6252

LaVision GmbH

Anna-Vandenhoeck-Ring 19
D-37081 Göttingen / Germany
E-mail: info@lavision.com / www.lavision.com
Tel. +49-(0)551-9004-0 / Fax +49-(0)551-9004-100

LaVision Inc.

211 W. Michigan Ave. / Suite 100
Ypsilanti, MI 48197 / USA
E-mail: sales@lavisioninc.com / www.lavisioninc.com
Phone: (734) 485 - 0913 / Fax: (240) 465 - 4306

Underwater 3D Flow Field Measurement

Lagrangian Particle Tracking with MiniShaker Underwater

For an instantaneous analysis, Fine Scale Reconstruction is performed for a grid spacing of $10 \times 10 \times 10$ vox. One realization is given in figure 13 showing isosurfaces of constant swirl strength color coded by the vorticity component ω_x . Directly, also the instantaneous pressure fields are retrieved.

Six planes of the pressure field of the same time-step as in figure 13 are displayed in figure 14. Even though, this is an instantaneous result, Fine Scale Reconstruction is capable of reconstructing the full flow field clearly showing the instantaneous position of the low-pressure core.

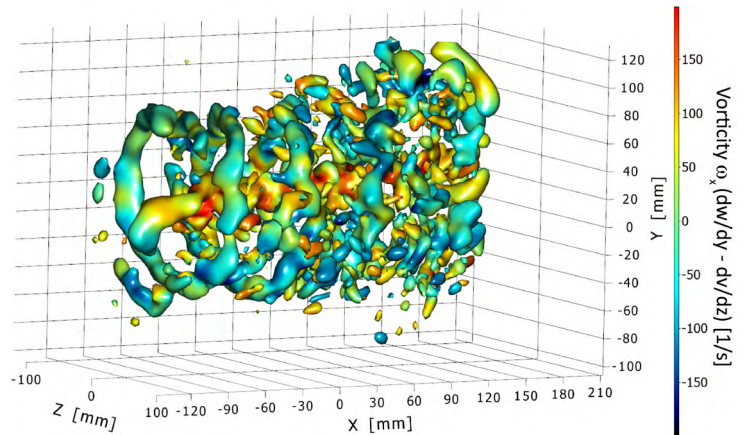

Figure 13: Wake of a two-bladed propeller with main flow direction parallel to the x-axis. Result of fine scale reconstruction at grid resolution $10 \times 10 \times 10$ vox. Isosurfaces at $\lambda_2 = -2500 \text{ s}^{-2}$ color coded by vorticity component ω_x

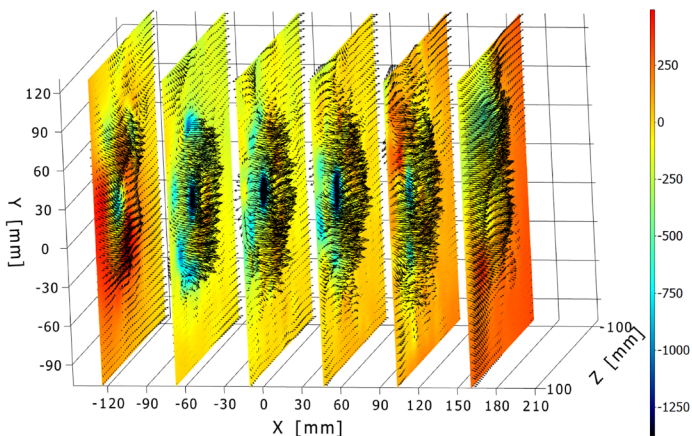

Figure 14: Six planes of a volumetric instantaneous pressure field retrieved by fine scale reconstruction, grid resolution $10 \times 10 \times 10$ vox. Every 4th vector of the velocity field is displayed. Shown is the same time step as in figure 13.

Using Shake-the-Box with Fine Scale Reconstruction and Pressure from PIV allows the experimentalist to unlock many aspects of physical phenomena. The high-quality, high-resolution velocity, acceleration and pressure fields provide unmatched experimental flow investigations to be achieved in a way that allows valuable insights into the flow physics and a clear path towards CFD validation.